



15"x2 TWO-WAY FULL RANGE **LA90V3** BASS-REFLEX LOUDSPEAKER SYSTEM

UNIT SELL POINT (USP):

- 100% Factory Quality Control
- 100% Factory Speaker Construction
- 100% Factory Tested
- Manufactured with Pride in the United States

APPLICATIONS:

- Concerts
- Clubs
- Mobile DJ
- Houses of Worship
- Entertainment

FEATURES:

- LV3 Technology
- Trapezoid Design
- Die-cast aluminum basket
- High sensitivity, low distortion
- SP DDPJ (Speaker Distortion Dynamic Protection)
- UPWEJ (Ultrachrome Protecting wood enclosures) black polyurea finish
- Compression driver with titanium diaphragm
- Manufactured with Pride in the United States
- Neutrik Speakon & Dual 1/4 Phone Jacks in Parallel



SPECIFICATIONS:

System Type:

2-way, Full range, bass ported

Frequency Range:

50 Hz - 18 kHz (-10 dB)

60 Hz - 16 kHz (+/-3 dB)

Power Capacity:

1200 W (Continuous)

4800 W (Peak)

Recommended Power Amplifier:

P.PA3

Sensitivity (1w/1m):

103 dB

Maximum Output:

140 dB

Nominal Impedance:

4 Ohms

Nominal Dispersion:

60° x 40°

Crossover Frequency:

2.0 kHz

Drivers:

LF (2 x Csp 15LV3)

HF (1 x Csp H450)

High Frequency Driver

Protection:

SP DDPJ

Input Connection:

One Neutrik Speakon Dual 1/4"

phone jacks in parallel

Enclosure Hardware:

3/4" MDF wood, UPWEJ black

polyurea finish

Grille:

18 gauge perforated steel,

additional powder coated

Dimensions (H x W x D):

45.375" x 19.875" x 20.375"

1153 mm x 505 mm x 518 mm

Weight:

119 lbs (53 kg)

Shipping weight:

125.5 lbs (56 kg)



15"x2 TWO-WAY FULL RANGE LA90V3 BASS-REFLEX LOUDSPEAKER SYSTEM

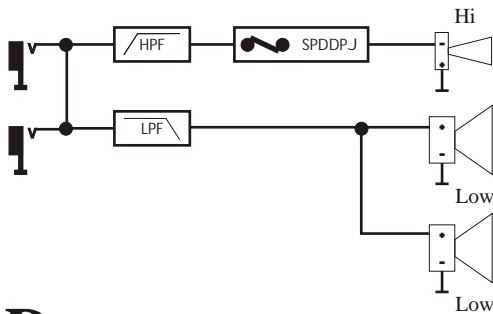
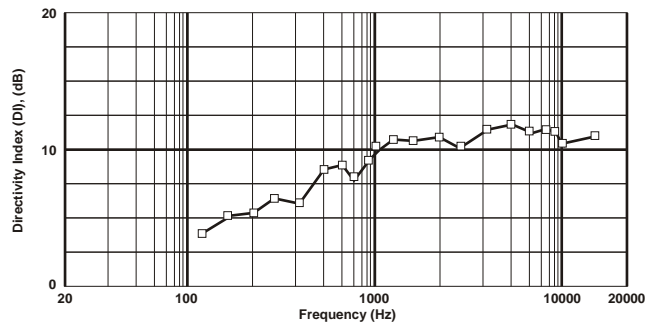
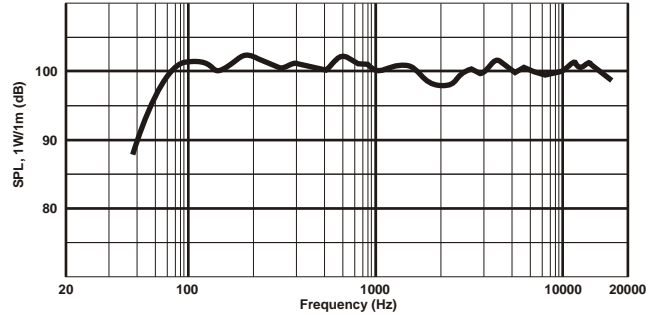

DIMENSIONS

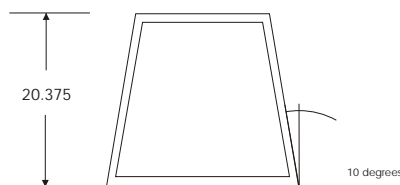
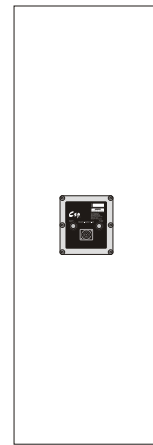
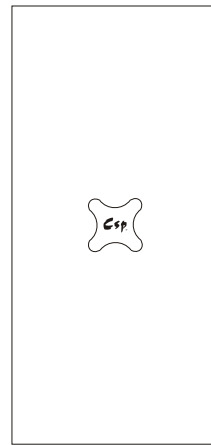
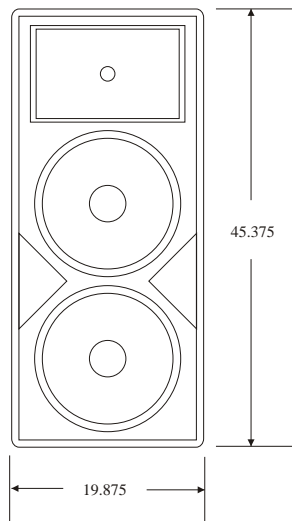

Dimensions in inch

Csp Professional

5157 Cliffwood Dr., Montclair, CA 91763 Tel: 909 590-5258 Fax: 909 590-1658 <http://www.csp-pro.com> info@csp-pro.com

© 2004, Csp Professional ★ Part # la90v3 ★ Csp professional member of Paul Audio Inc.